

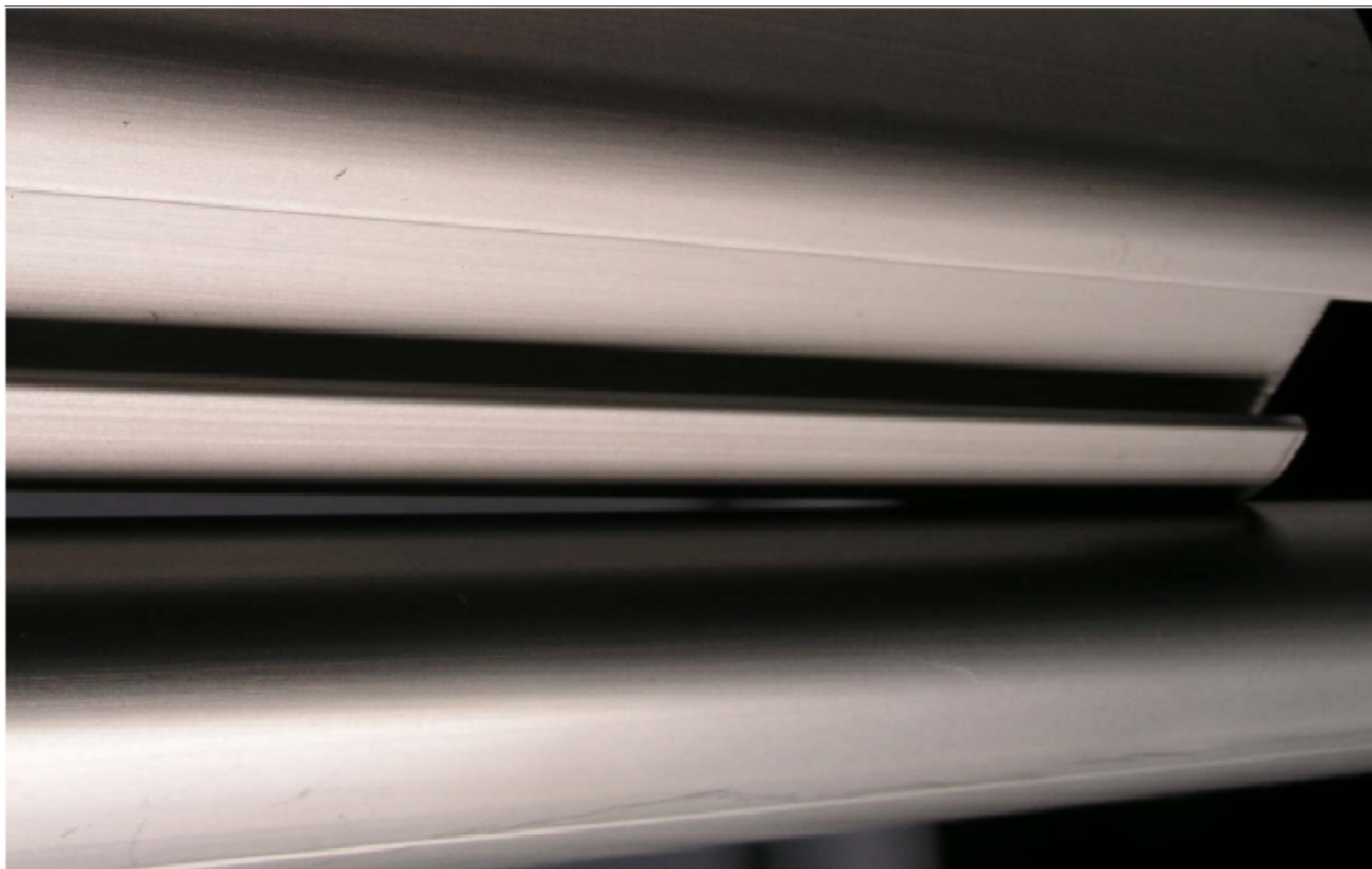

Decor-Alum
ALUMINIO



Distribuidor de aluminios y accesorios



Accesorios Panorama



www.decoralum.com.ar - info@decoralum.com.ar
Belgrano 3740 (1210) Cap. Fed. (011) 4931-3428 / 4956-0726 / 4957-0264



Decor-Alum

ALUMINIO



Distribuidor de aluminios y accesorios

Accesorios Baranda Panorama

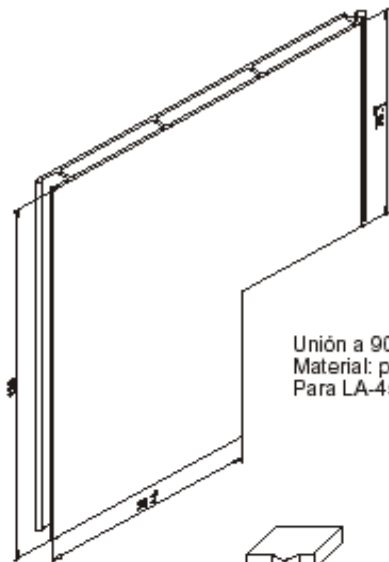

Unión a 90°
Material: perfil LA-926
Para LA-4500

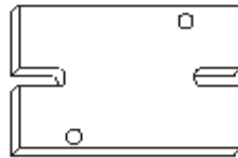

SUP-627
Soporte
Material: aluminio

Tuerca con nylon
autobloqueante



Tornillo cabeza hexagonal
Ø 1/4 x 1"

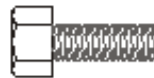

POR-517
Material: acero zincado
POR-519
Material: acero inoxidable

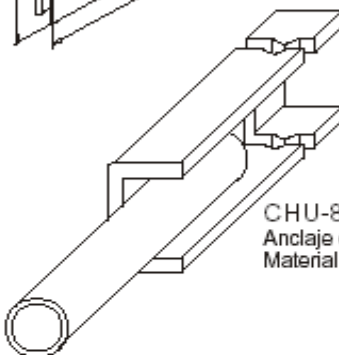

CHU-859
Anclaje de columnas
Material: acero inoxidable

PAR-656
Material: acero zincado
PAR-690
Material: acero inoxidable



POR-502
Material: acero zincado

POR-518
Material: acero inoxidable



ARR-553
Material: acero zincado
ARR-568
Material: acero inoxidable

Tornillo autorroscante
Ø 4,8 x 16 mm



PAR-229
Material: acero zincado
PAR-691
Material: acero inoxidable

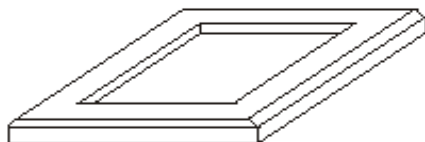

CAN625
Material: poliamida 6.6

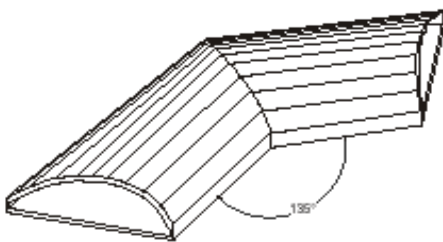

CON-356
Unión a 135°
Material: aluminio soldado
para CG-143

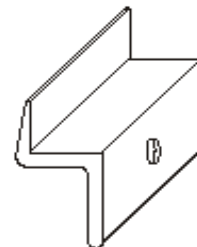

SUP-626
Material: aluminio

Capuchón



NYL-314
Material: poliamida 6.6

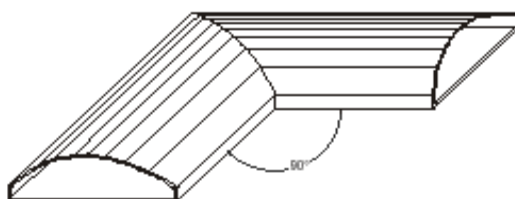

CON-357
Unión a 90°
Material: aluminio soldado
Para CG-143

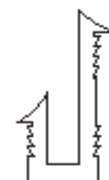

GUA-034
Burlete vidrio 5/8 mm
Material: EPDM
GUA-033
Burlete vidrio 7/8 mm
Material: EPDM



www.decoralum.com.ar - info@decoralum.com.ar

Belgrano 3740 (1210) Cap. Fed. (011) 4931-3428 / 4956-0726 / 4957-0264